

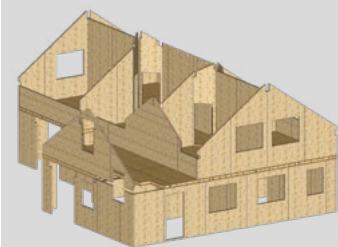

# NOVATOP SYSTEM

Procedure for processing  
Instructions for assembly



NOVATOP 

# NOVATOP SYSTEM CONTENT

---

Procedure for processing .....	3-18
Instructions for assembly .....	19-28

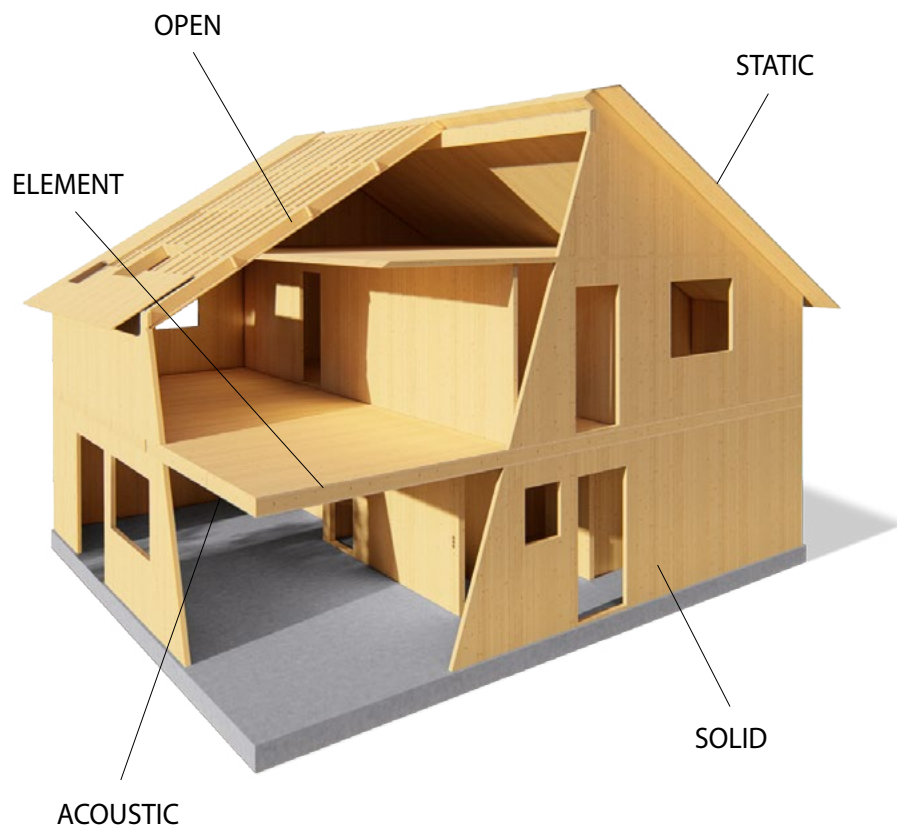

# PLANNING OF DESIGN AND PRODUCTION

Planning stages describe the individual steps and their approximate time requirements. The actual time requirement depends on the size and complexity of the order and the current production capacity. Our individual custom production requires a high level of pre-planning and processing of project documentation well in advance.

**Note:** from the final approval of the drawings (point 9), it is necessary to prepare and manufacture the panels - 6 to 14 weeks.

## For the timely delivery of your order, the most important items are:

- joint planning
- consistent meeting of the deadlines
- mutual cooperation

### WE NEED FROM YOU

- 1. THE STUDY OF THE PROJECT**
- 2. PRELIMINARY CALCULATIONS** (Can be made already on the basis of the project study)
- 3. PROJECT DOCUMENTATION**  
Must contain:
  1. A 3D model or 2D drawings (We prefer the documents to be processed in a 3D model and formats: cadWork, ifc, sat, stp, BTL.)
  2. Ground plans
  3. Sections
  4. Views of individual walls, ceilings and roof structures
  5. Wall thicknesses and element specifications
  6. Indication of the visual quality and orientation of the fibres
  7. Indication of electrical wiring
  8. Requirements for fire resistance (REI), sound and thermal insulation
  9. Construction details (types of joints and connections)
  10. Connecting elements
  11. Warning of non-standard execution
  12. The preliminary installation procedure (wall numbering)
  13. Structural analysis
- 4. CONSULTATIONS AND RECOMMENDATIONS ON THE PROJECT DOCUMENTATION**
- 5. CONTINUOUS PRICE OFFER**
- 6. THE FINAL PROJECT DOCUMENTATION**  
Must contain, see point 3
- 7. CONTINUOUS PRICE OFFER**
- 8. DRAWINGS TO BE CONFIRMED**  
3D models, 2D drawings - the distribution of the panels, how they will be delivered to the construction site, the layout plan
- 9. THE FINAL APPROVAL OF THE DRAWINGS**  
The basis for the production documentation cannot be changed after it has been approved!
- 10. THE FINAL PRICE OFFER**
- 11. THE PRODUCTION DOCUMENTATION**  
Detailed drawings and division of the panels into individual parts (sent to the client only for information)
- 12. PRODUCTION OF PANELS**  
The production process can be started if the drawings are approved, the contract is signed and the deposit is paid).
- 13. SHIPPING**  
The method of transport is chosen according to the final formats of the individual panels, with the connection to unloading and assembly. A package list and a method of loading the truck are included in the delivery.

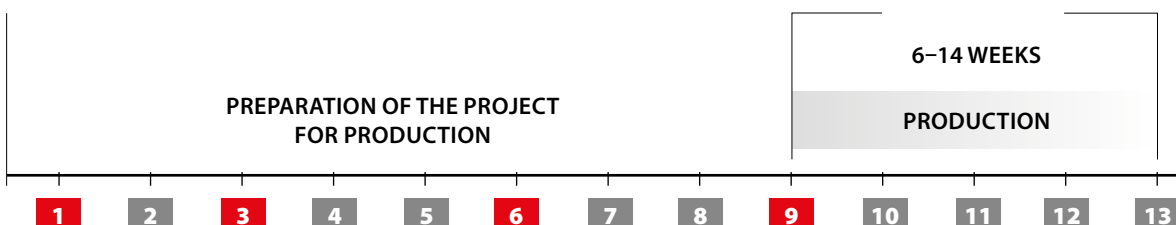

**WE NEED FROM YOU**

**THE PROJECT DOCUMENTATION MUST CONTAIN**

1. A 3D model or 2D drawings (We prefer the documents to be processed in a 3D model and formats: cadWork, ifc, sat, stp, BTL.)
2. Ground plans
3. Sections
4. Views of individual walls, ceilings and roof structures
5. Wall thicknesses and element specifications
6. Indication of the visual quality and orientation of the fibres
7. Indication of electrical wiring
8. Requirements for fire resistance (REI), sound and thermal insulation
9. Construction details (types of joints and connections) see the catalogue of construction details
10. Connecting elements
11. Warning of non-standard execution
12. The preliminary installation procedure (wall numbering) 2D
13. Structural analysis

**AN EXAMPLE OF A COMPLETE 3D MODEL**

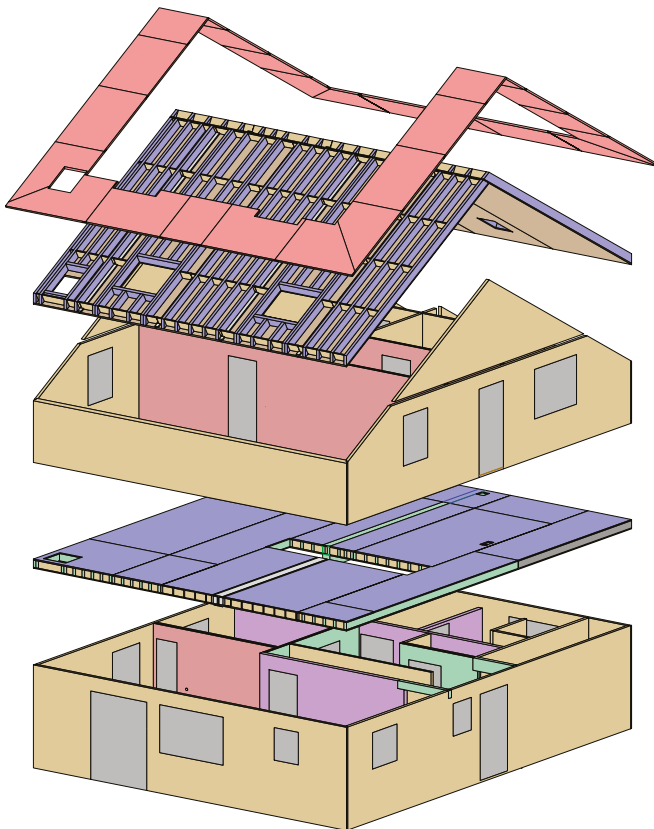

**WALLS - 1ST FLOOR**



2D



**ROOF**

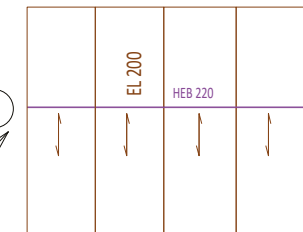

2D

**WALLS - 2ST FLOOR**

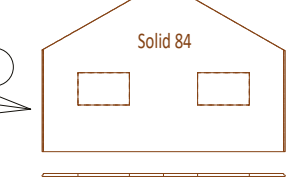

2D

**ROOF**

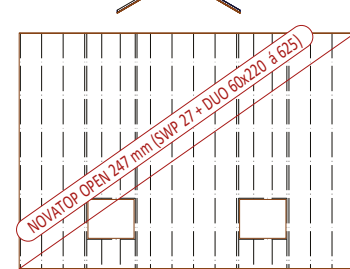

2D

**Roof overhangs**

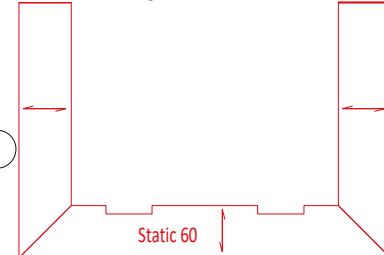

2D

# WALLS

## THE BASIS FOR PREPARATION OF THE PROJECT DOCUMENTATION

We recommend NOVATOP SOLID panels for the construction of load bearing and non-load-bearing walls. Their use is based on the required load, visual quality, fire resistance and sound insulation properties  
([See the NOVATOP Open Technical Documentation for details](#)).

### Thickness:

62, 84 (42/42), 124 (62/62) mm

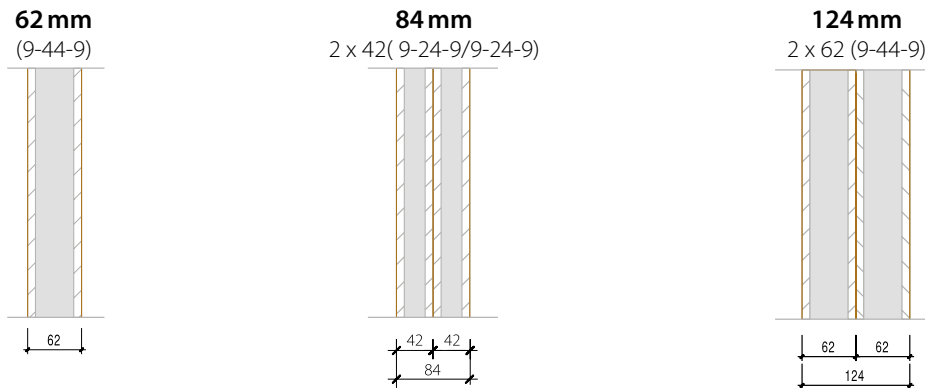

### Standard formats:

6 000 x 2 500, 6 000 x 2 100, 5 000 x 2 500, 5 000 x 2 100 mm (max. 12 000 x 2 950 mm)  
Other formats are based on the following basic formats.

### Quality:

Visual living space (B) and no-visual construction (C).

For the interior, we recommend panels NOVATOP SOLID in the visual quality of the thickness of 84 mm, or possibly 124 mm.

### Dimensioning :

Wall dimensioning - see the pre-dimensioning tables according to ETA-17/0004.

([See the NOVATOP SOLID Technical Documentation](#).)

### Structure composition:

The choice of wall structure compositions should be made from the [Construction details catalogue](#) according to the U-coefficient of heat transfer, fire resistance, visual quality and sound-insulating properties.

## INCLUSION OF THE WALLS IN THE GROUND PLAN OF THE BUILDING

It is recommended to use standard formats and select the connection of the walls in the corners and the inner walls from the catalogue of the structural details (a link to the production and installation documentation). When using larger formats, we recommend a maximum panel height of 2.95 m (restriction of pressing and transport possibilities).

AN EXAMPLE OF PROJECT DOCUMENTATION

**WE NEED FROM YOU**

1. A 3D model or 2D drawings (in the following formats: dwg or dxf)
2. Ground plans
3. Sections
4. Views of individual walls including the size and location of window and door openings
5. Wall thicknesses
6. Indication of the visual quality and orientation of the fibres
7. Indication of electrical wiring
8. Requirements for fire resistance (REI), sound and thermal insulation
9. Warning of non-standard execution
10. Construction details (types of corner joints and panel connections)
11. Connecting elements
12. The preliminary installation procedure (wall numbering)
13. Structural analysis

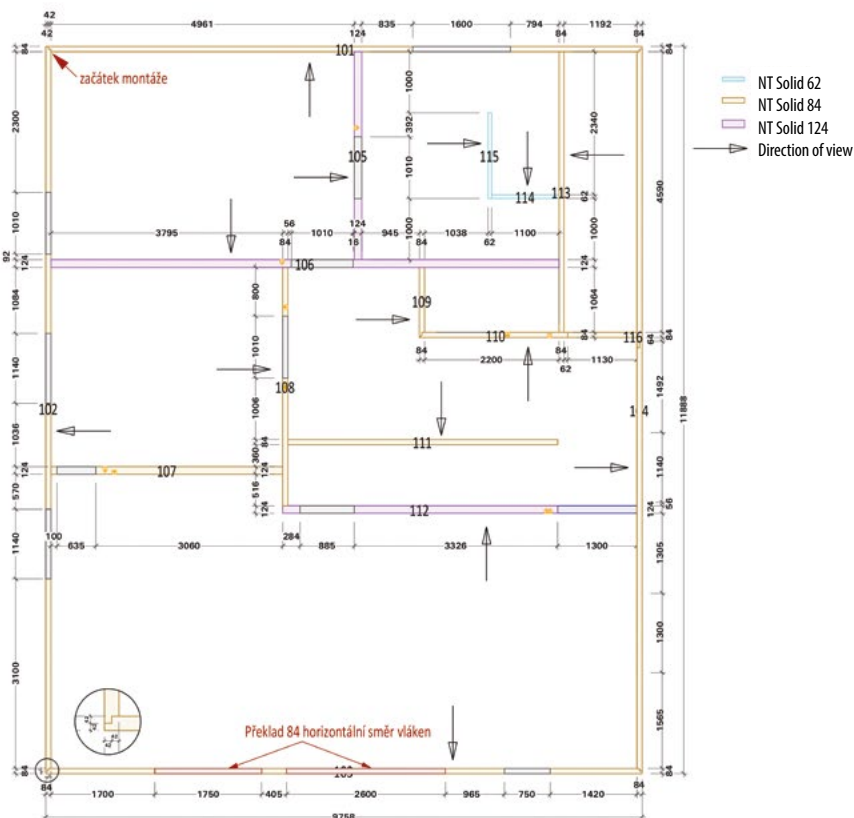

An example of a view of the individual walls:

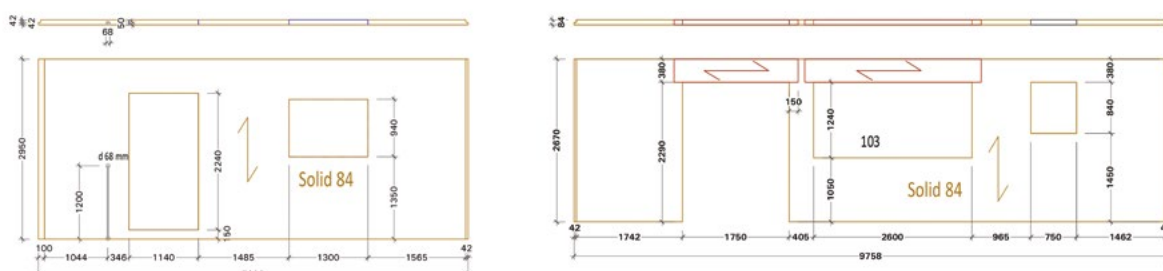



# WALLS

## AN EXAMPLE OF A PROJECT DOCUMENTATION TO BE CONFIRMED

You will receive from us:

1. Detailed drawings and division of the panels into individual parts.
2. Number of parts from which each wall will be delivered (Marked 101a, 101b ...)
3. The fibre direction is defined by the direction of the description.
4. The direction of the view is indicated on the drawing.

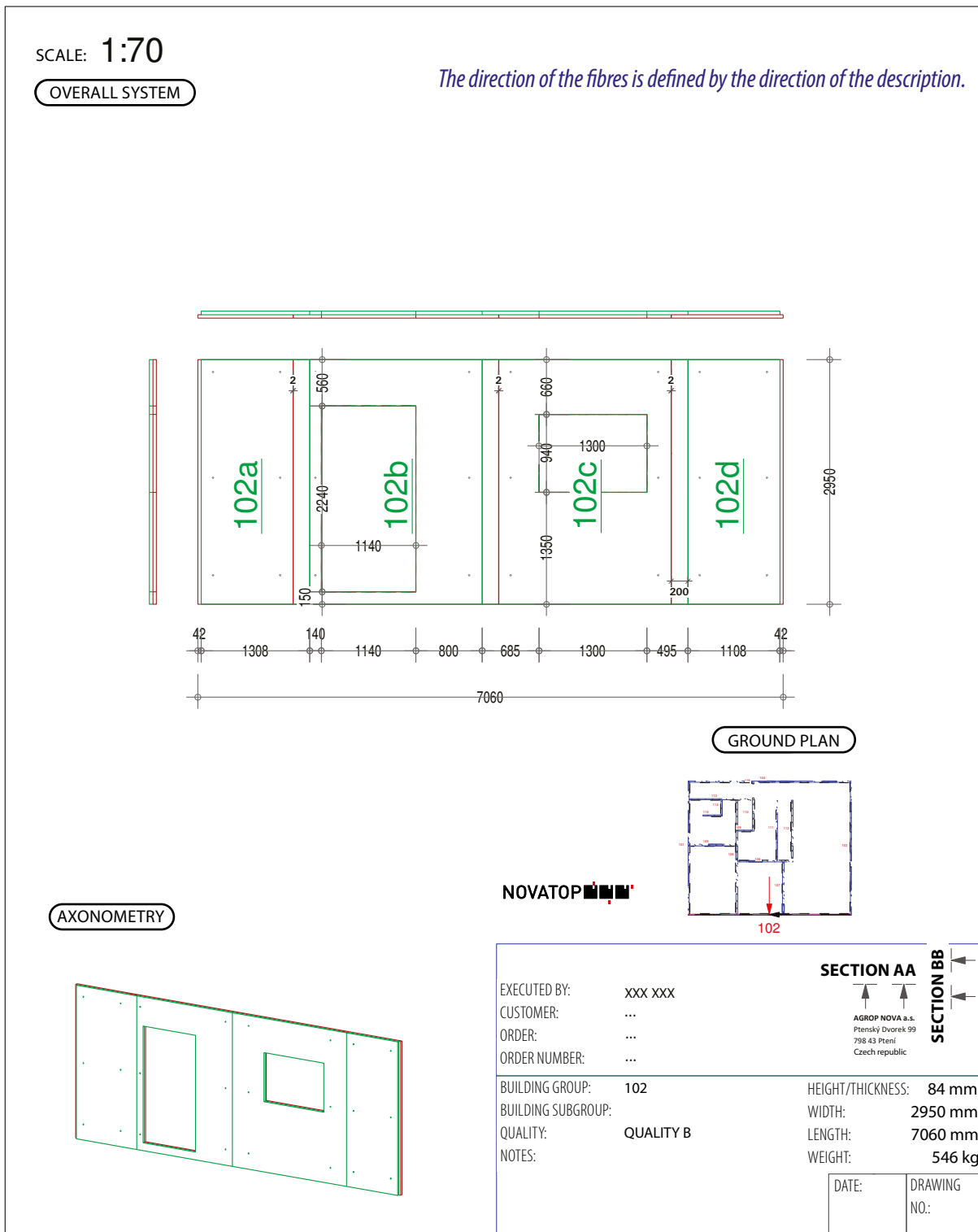

AN EXAMPLE OF A PROJECT DOCUMENTATION TO BE CONFIRMED

An example of a wall with a lintel with a horizontal fibre direction:

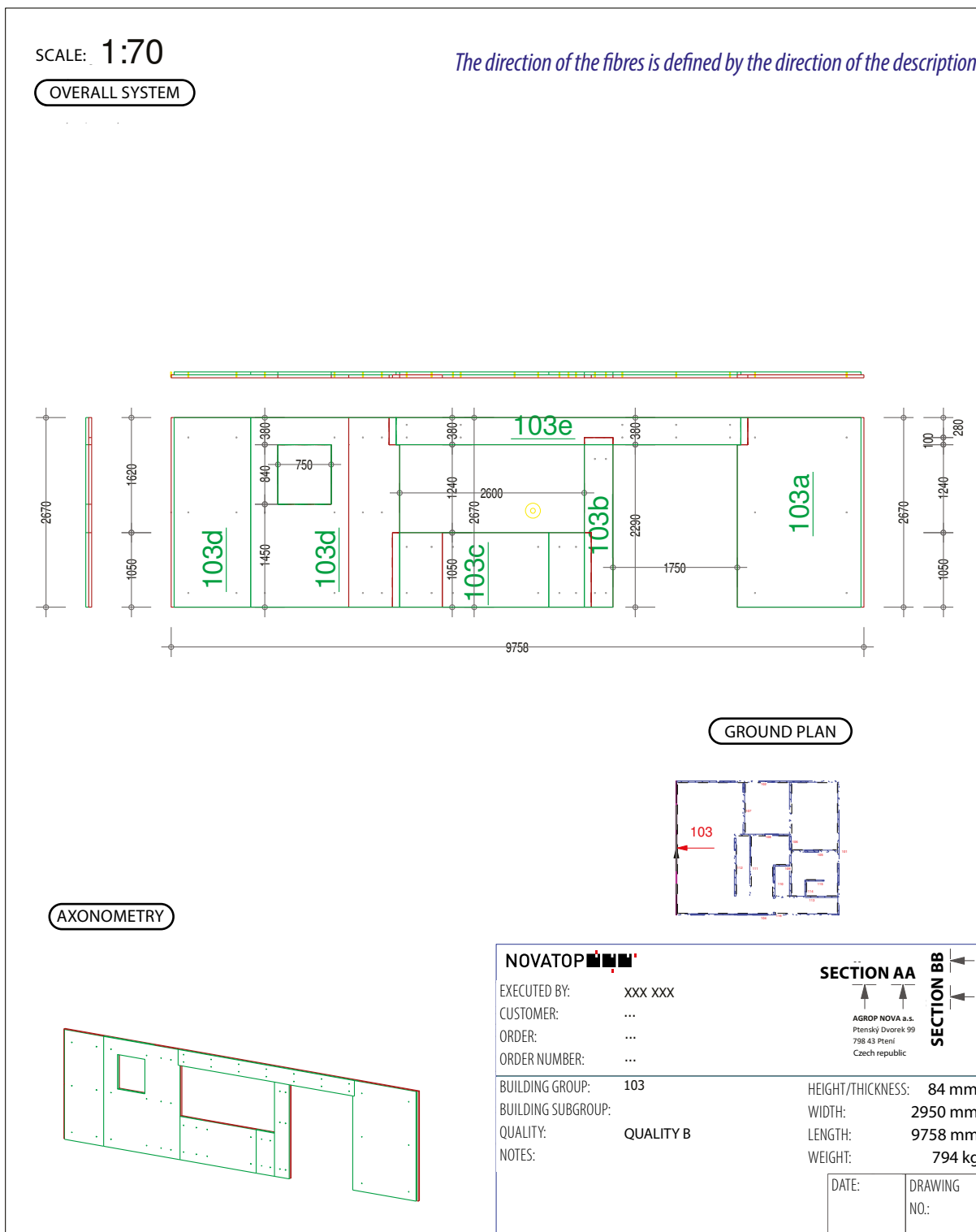



# CEILINGS

## THE BASIS FOR PREPARATION OF THE PROJECT DOCUMENTATION

We recommend NOVATOP ELEMENT panels for the construction of ceilings; their type and use depend on the span and placement possibilities. It is necessary to take into account the fire resistance of the panels.

**Widths:** 1 030, 2 090, 2 450, max. 2 450 mm

**Lengths:** According to the project documentation, standardly 6,000, maximum 12,000 mm Above 6,000 mm, the length extension is to be made with a dowtail joint with a reinforcement of the bearing joint up to a maximum length of 12,000 mm, or it is possible to use long boards of maximum 10,000 mm with a continuous surface lamella.

**Heights:** 160, 180, 200, 220, 240, 280, 300, 320, max. 400 mm

**Qualities of the bottom board of the element:** Visual (B) and no-visual (C)

(See the NOVATOP ELEMENT Technical Documentation for details).

### Dimensioning:

- see the pre-dimensioning tables in the [NOVATOP Element Technical Documentation](#).
- or special software for dimensioning elements [see the downloads section](#).

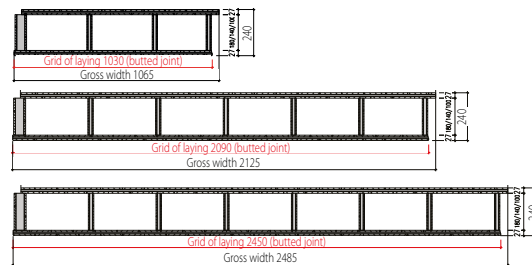
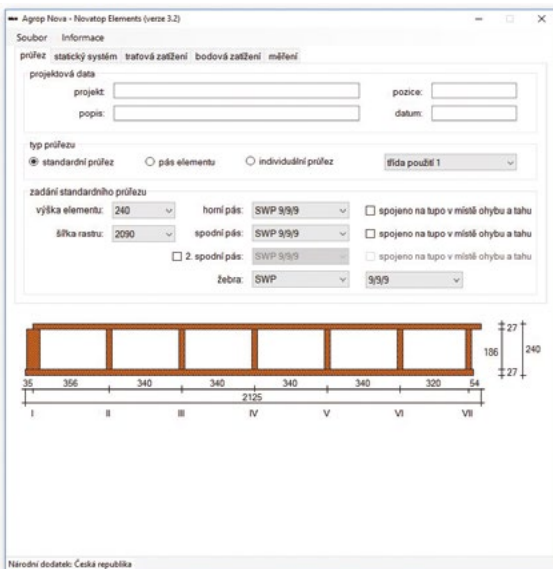

### An example of placement of elements:

The minimum width of the ceiling elements is 40 mm. At the place of contact of 2 panels on the inner bearing wall, the wall thickness must be at least 84 mm (ND 204). Placement of the element on the peripheral wall is usually across the entire width of the wall (ND 201). Other placement options, see the catalogue of the [Structural details](#).

#### ND 204

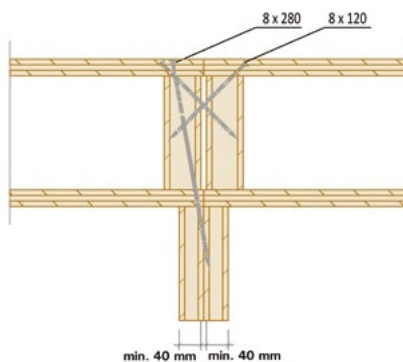

#### ND 201

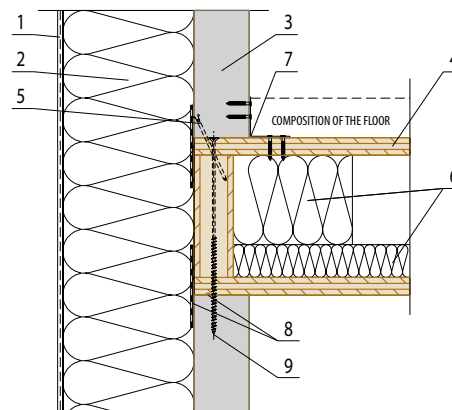

## AN EXAMPLE OF PROJECT DOCUMENTATION

### WE NEED FROM YOU

(We prefer the documents to be processed in a 3D model).

1. Ground plans with the inclusion of NOVATOP Element panels marked with the directions and placement options
2. Types of elements
3. Static reinforcement requirements
4. Indication of the visual quality
5. Indication of electrical wiring
6. Requirements for fire resistance (REI), sound and thermal insulation
7. Warning of non-standard execution: Particular attention must be paid to the placement and the method of execution around the staircase and in places with large openings (e.g. French windows).
8. The preliminary installation procedure
9. Structural analysis (it is necessary to consider the maximum weight of the elements).

### An example of panel layout:

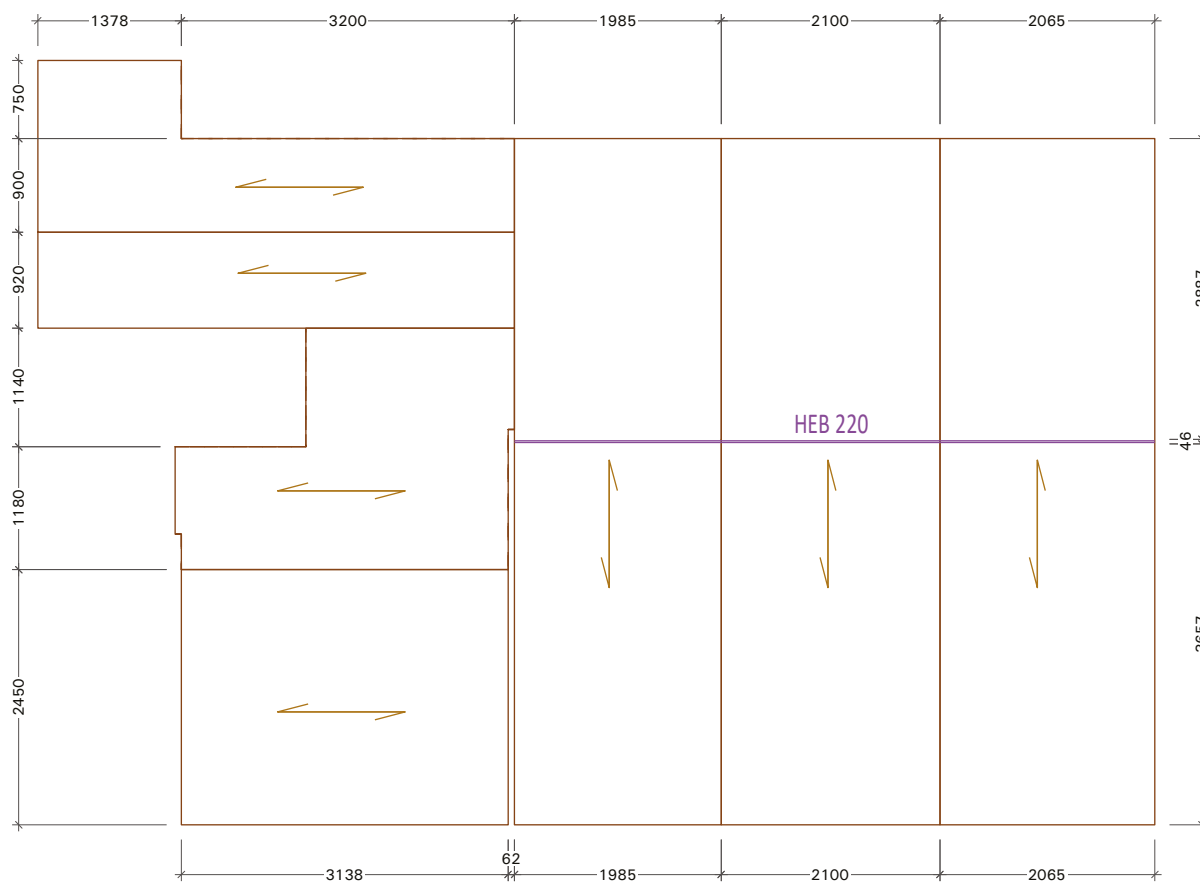

### An example of an assignment:

NOVATOP ELEMENT	220 mm
Quality	visual (B)
Fire resistance	REI 60
Thermal insulation	Steico Flex



# CEILINGS

## AN EXAMPLE OF A PROJECT DOCUMENTATION TO BE CONFIRMED

You will receive from us detailed drawings and division of the elements into individual parts, see the picture.

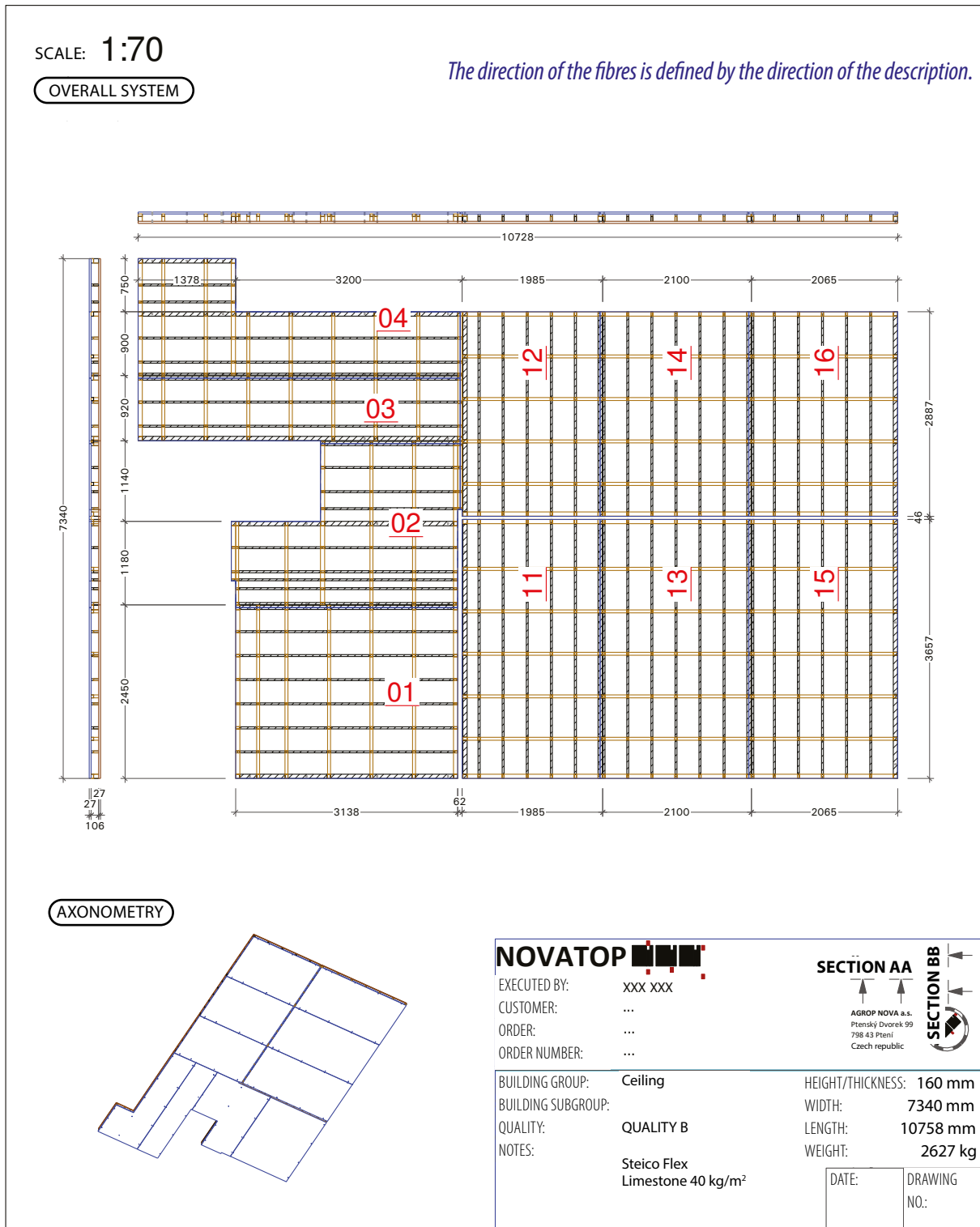

## THE BASIS FOR PREPARATION OF THE PROJECT DOCUMENTATION

We recommend NOVATOP OPEN panels for the construction of roofs; their type depends on the use.

**Widths:** 1030, 2090, 2450, max. 2.450 mm

**Lengths:** according to the project documentation, standardly 6,000, maximum 12,000 mm

**Maximum format:** 12,000 x 2,450 mm (Extension of the SWP with a dowtail joint)

**Total heights:** 227 mm, 247 mm, 267 mm and other

**SWP thicknesses:** 27 mm (9/9/9), 19 mm (6/7/6).

**KVH dimensions (DUO,TRIO,BSH, I-girders):** 200/60; 220/60; 240/60 mm and other

**Qualities of the bottom board of the element:** Visual (B) and no-visual (C)

### Dimensioning:

Depends on dimensioning of KVH/DUO prisms. It is possible to take into account the interaction of SWP of thickness 27 with prisms according to ETA 15/0209.

[NOVATOP Open Technical Documentation for details](#).

## AN EXAMPLE OF A PROJECT DOCUMENTATION

### WE NEED FROM YOU

(We prefer the documents to be processed in a 3D model )

- tilted views marked with the directions and placement options
- types of elements, including defining the dimensional and prism pitch requirements
- indication of the visual quality
- indication of electrical wiring
- requirements for fire resistance (REI) and thermal insulation
- warning of non-standard execution: Particular attention must be paid to selecting the correct detail of the top connection and to indicate the use of metal connecting elements and reinforcement.
- the preliminary installation procedure
- structural analysis (it is necessary to consider the maximum weight of the elements).

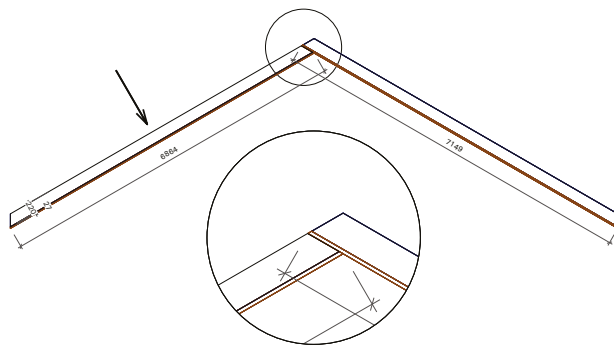

A view perpendicular to the panel plane

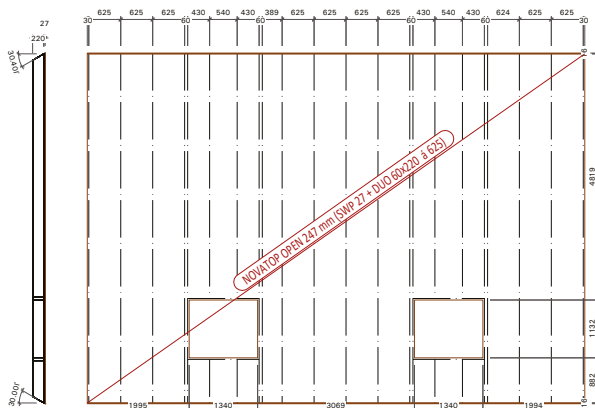

### An example of an assignment:

NOVATOP OPEN	247 mm
Quality	visual (B)
Thermal insulation	Steico Flex

# ROOFS

## AN EXAMPLE OF A PROJECT DOCUMENTATION TO BE CONFIRMED

You will receive from us detailed drawings and division of the elements into individual parts, see the picture.

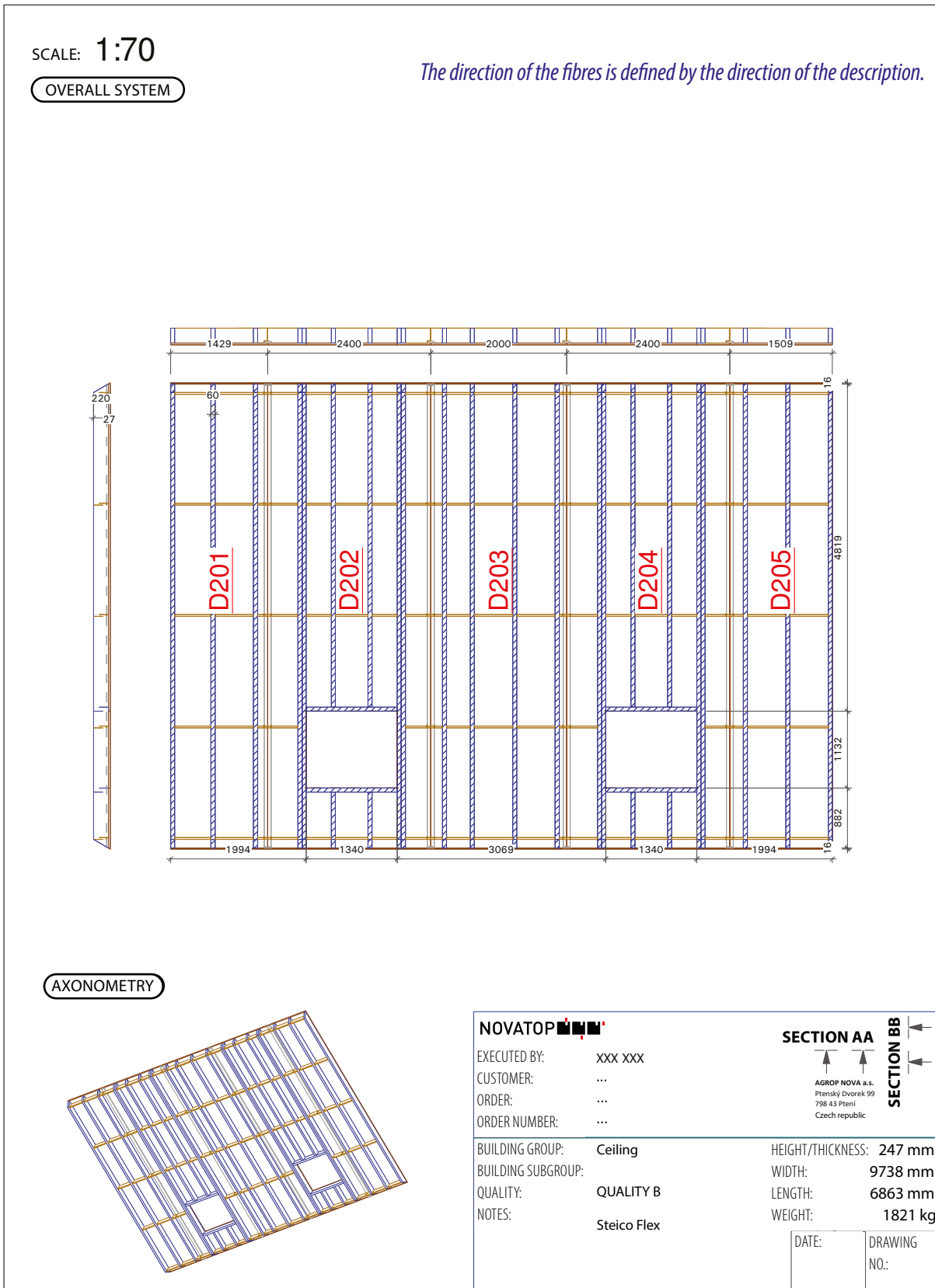

## DATA FOR PROCESSING PROJECT DOCUMENTATION

We recommend NOVATOP STATIC panels for the construction of roof overhangs; their type depends on the use.

**Thicknesses (mm):** 45, 60

### NOVATOP STATIC L

Longitudinal direction of the fibres of the surface lamellas.

**Standard lengths (mm):** 2 500, 5 000, 6 000

**Maximum length (mm):** up to 12 000 (with a dowtail joint)

**Widths (mm):** 1 040, 1 250, 2 100, 2 500

### NOVATOP STATIC Q

Transverse direction of the fibres of the surface lamellas

**Standard length (mm):** 4 950 (with a dowtail joint)

**Width (mm):** 2 500

**Qualities:** visual (interior), no-visual (structural).

### Dimensioning:

Dimensioning of roof overhangs - see the tables in the [NOVATOP STATIC Technical Documentation](#).

[See the NOVATOP STATIC Technical Documentation for details.](#)

## AN EXAMPLE OF A PROJECT DOCUMENTATION

### WE NEED FROM YOU

(We prefer the documents to be processed in a 3D model).

1. Tilted views marked with the directions and placement options
2. Panel thicknesses
3. Fibre orientation
4. Definition of corner connections
5. Indication of the visual quality
6. Requirements for fire resistance (REI)
7. Structural analysis (it is necessary to consider the maximum weight of the elements).

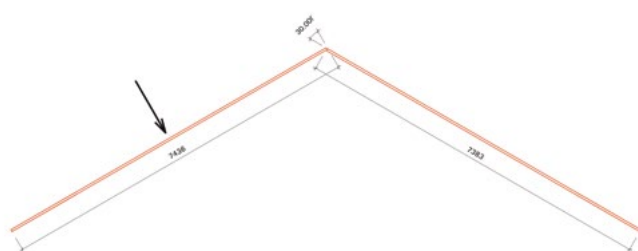

### An example of an assignment:

NOVATOP STATIC	60 mm
Quality	visual (B)

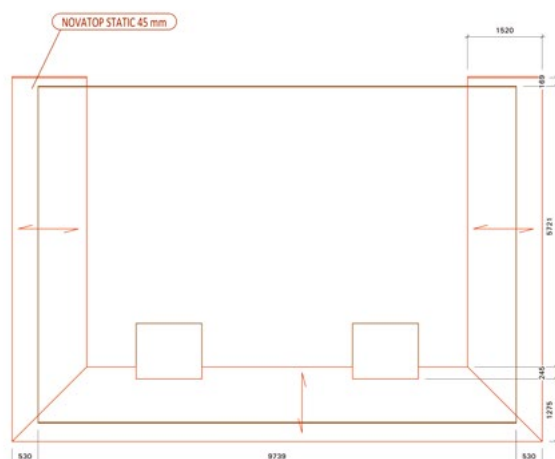

# PŘESAHY STŘECHY

## AN EXAMPLE OF A PROJECT DOCUMENTATION TO BE CONFIRMED

You will receive from us detailed drawings and division of the elements into individual parts, see the picture.

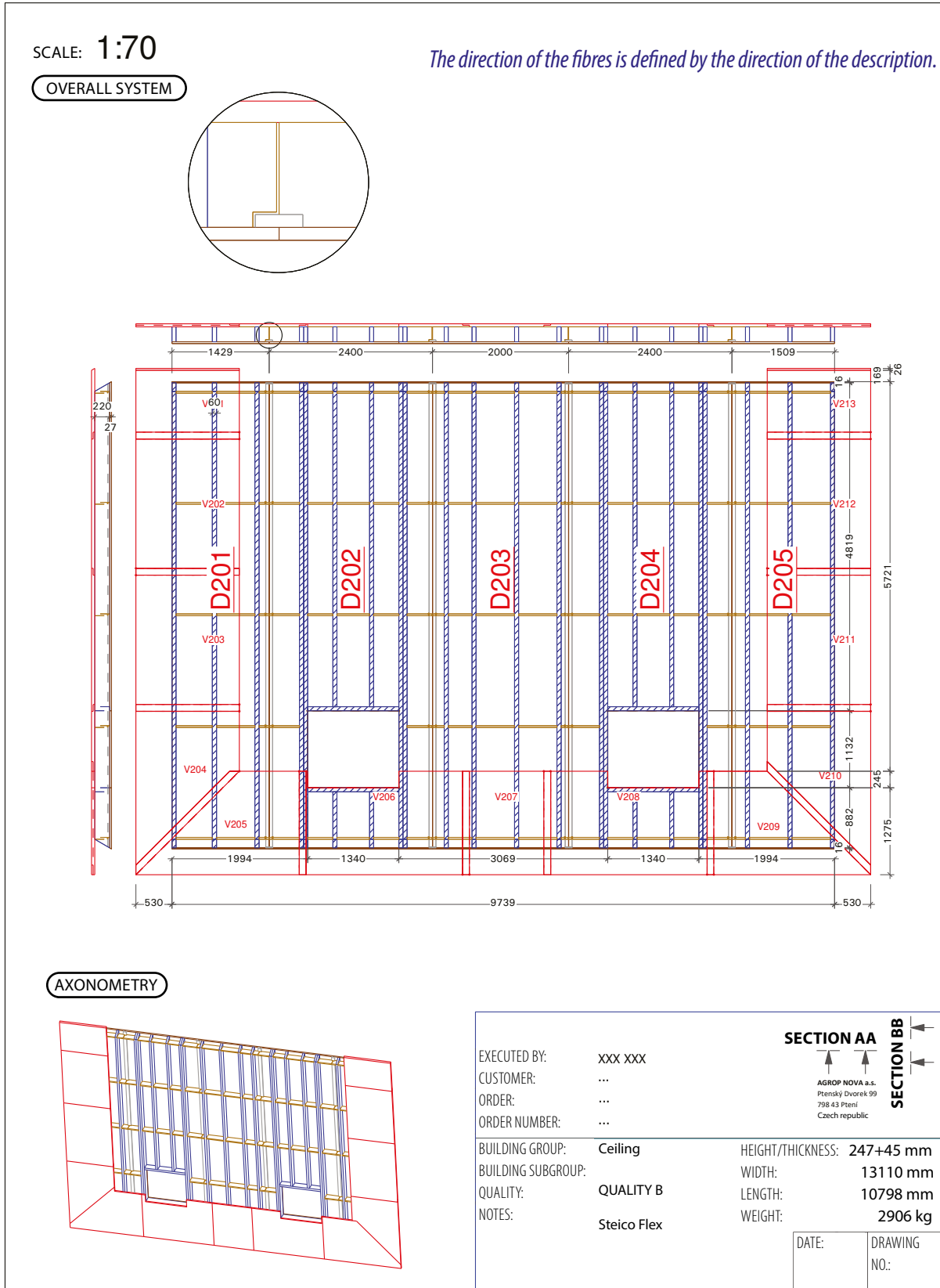

**WE NEED FROM YOU**

Information on the mode of transportation and placement of the panels on the truck in connection with your unloading and installation.

## GENERAL INFORMATION

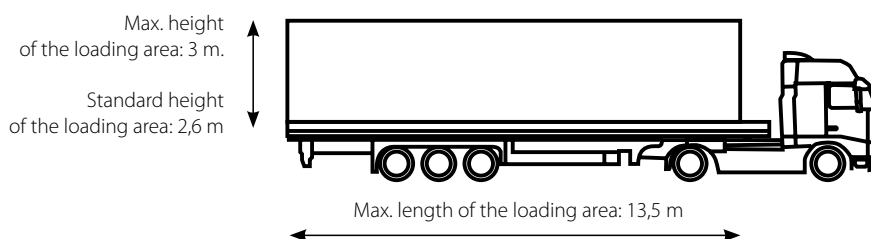

**Maximum load parameters:** 50 m<sup>3</sup>/24 t (we expect to use approximately 35 m<sup>3</sup> due to non-standard packages).

**Standard weight of packages:** 2,5 t 2.5 t (other weights need to be entered in the requirements - maximum 5 t)

The standard mode of transportation is horizontally, however, there is an option of vertical loading (special A structures).

Transport of NOVATOP panels is possible on different types of trucks and depends on the dimensions of the packages, the way of unloading and the transport accessibility to the site. It is necessary to ensure entry and exit of these vehicles into/from the construction site.

package width	length packet	way of landing	transportation facilities	supplementary charge
≤ 2,1 m	max. 6 m	electric crane	trailer with a standard-size sheet	
		lift truck	trailer with a standard-size sheet	
max. 2,4 m	max. 12 m	electric crane	trailer with a sheet with a possibility of removing the support in the upper part	
		lift truck	trailer with a sheet with the possibility of displacement of the central pillars	
max. 2,5 m	max. 6,5 m	electric crane	uncovered trailer	✓
		lift truck	trailer with a sheet with the possibility of displacement of the central pillars	
max. 2,48 m	max. 12 m	electric crane	uncovered trailer	✓
		lift truck	trailer with a sheet with the possibility of displacement of the central pillars	
2,5–3 m	max. 12 m	crane	uncovered trailer	✓
		lift truck	uncovered trailer	✓
Vertical placement max. 2,80 m	max. 12 m	electric crane	uncovered trailer	✓
		lift truck	trailer with a sheet with the possibility of displacement of the central pillars	✓
Container	20' 40' 40' High Cube	electric crane	Open Top (from the upper side)	✓
		lift truck	Standard (from the back side)	✓



# TRANSPORT

## AN EXAMPLE OF THE METHOD OF LOADING AND THE PACKAGE LIST

- \*Truck layout is only for reference reasons
- \*The packages are considered to be an exact cuboid (L x W x H)
- \*Inaccuracies of the packages are not taken into consideration

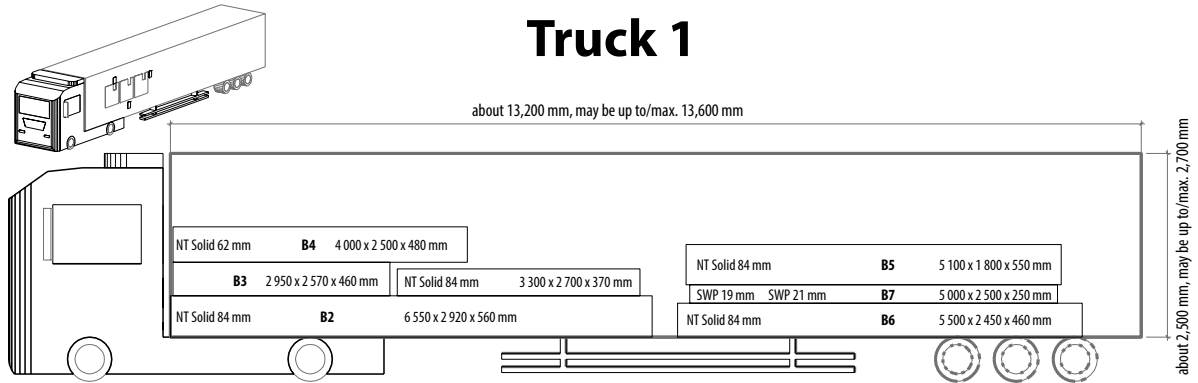

## NOVATOP

CUSTOMER	XXX
OBJECT	XXX
DATE	XXX

PACKAGE 1		Length:	3300 mm
PACKAGE CONTENT: NT Solid 84mm	<b>104b, 104d, 101a, 101b, 101d, 101e 104a, 104e 104c</b>	Width:	2700 mm
		Height:	370 mm
		Weight: (approx.)	840 kg
		Truck volume:	50 m <sup>3</sup>
		Package volume:	3,30 m <sup>3</sup>
		NUMBER	9

PACKAGE 2		Length:	6550 mm
PACKAGE CONTENT: NT Solid 84 mm	<b>101c 101f 102a 103b 103c</b>	Width:	2920 mm
		Height:	560 mm
		Weight: (approx.)	2500 kg
		Truck volume:	50 m <sup>3</sup>
		Package volume:	10,71 m <sup>3</sup>
		NUMBER	5

# NOVATOP SYSTEM INSTRUCTIONS FOR ASSEMBLY

The assembly instructions contain basic information and recommendations. Responsibility for the correct execution of the construction is assumed by the implementing company that complies with the current technical standards. Implementation companies are recommended to complete training prior to the first assembly.

## INSTRUMENTS:

Suspension bolts, eccentric hinges (2 pcs), reversible lifting straps (4 pcs), crane straps, adjustable struts for ensuring in the vertical position (5 pcs or more), drills (drilling in concrete, screwing of the hinges and screws), ratchets tightening (preferably 2 pieces), a water level, a levelling instrument if possible, ladders, mallets.

**Warning:** It is important to remember the sequence of the assembly. For the trucks, it is necessary to ensure entrance in and exit from the site, for the lifting machinery, it is necessary to define the maximum lifting load and range.

## EQUIPMENT:

Anchors (L profile), screws with a dowel (or others), airtight dichtband, wooden pads for underlying of the panels, Construction Screws: Dual head with a disc drive (8 x 160, or another one), torque: (6 x 60, or another one) and others as needed. Filling of joints: silicone, polyurethane putty, polyurethane glue, etc.

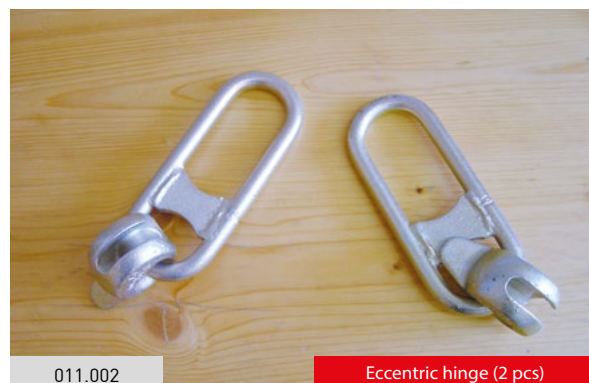
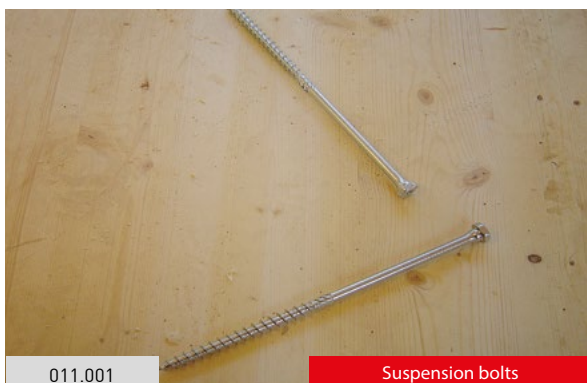

# NOVATOP SYSTEM INSTRUCTIONS FOR ASSEMBLY

## 1. PREPARATION OF THE BASE PLATE

It is very important that the base plate and the position of the individual walls are measured as precisely as possible, due to the smooth assembly process and the connection of the individual panels. It is good to check the length of the diagonals. Install the assembling anchors based on the drawing documentation (for 1 panel of the width of 2.5 m - about 2 anchors - about 20 cm from the edges).

NOVATOP wall panels can be placed either directly on the stripped base plate, **fig. 1** then it is advisable to leave a gap due to possible unevenness of the base plate, so that the individual panels could be flat, or the panels can be placed on a pre-prepared base beam/prism **fig. 2**. Measure the base beams in advance, place it in a horizontal position and anchor it to the base plate (for example, using screws with a dowel in the central part, wherein the screw is sunk in the prism). Then fasten the NOVATOP wall panel to the base plate using anchors (L profile). The subsequent assembly is then simpler and faster.



fig. 1



fig. 2

## 2. INSTALLATION OF NOVATOP SOLID WALLS

All NOVATOP wall panels are provided with identification labels indicating the panel position number in the wall. The labels are placed at the top edge **fig. 3** and at the bottom part of the panel; the inner side of the panel is thus marked in the peripheral walls **fig. 4**.

Suspensions bolts are drilled to the panels from above (the upper side with the label, if not already prepared by the manufacturer) **fig. 5a** and are attached to the crane arm **fig. 5b** using an eccentric hinge.



fig. 3



fig. 4



fig. 5a

fig. 5b

# NOVATOP SYSTEM INSTRUCTIONS FOR ASSEMBLY

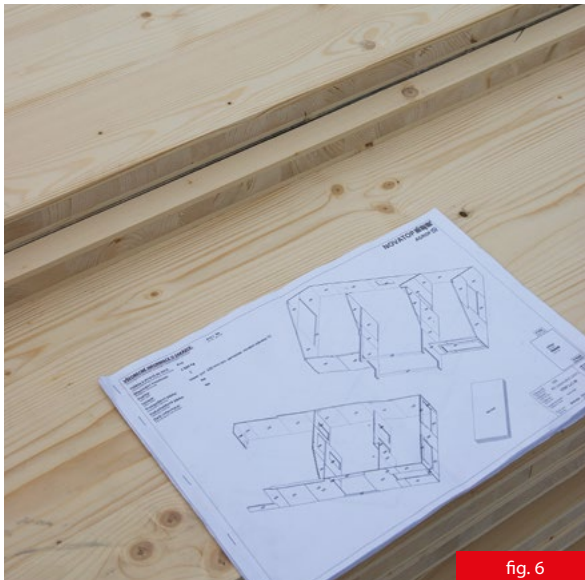

fig. 6

The individual NOVATOP wall panels are installed gradually according to the assembly sequence (panel numbers) **fig. 6**.

Each NOVATOP panel is secured with a strut **fig. 7** and attached to the prepared anchors at the bottom side **fig. 8**. After levelling and checking the position, secure the anchors with additional screws. The best is to start with a corner joint or, where appropriate, with other structures in order to ensure the initial stability of the panels and the joint **fig. 9**.



fig. 8



fig. 7



fig. 9

# NOVATOP SYSTEM INSTRUCTIONS FOR ASSEMBLY

Another NOVATOP panel may be equipped with an airtight butyl sealant tape [fig. 11](#) filling is applied to the longitudinal joints [fig. 12](#) . Pay attention to the careful execution of the joint in order to secure its maximum airtightness!



Another NOVATOP panel is placed as close as possible to the final position using the crane [fig. 13](#) . The exact position can be secured with tightening ratchets [fig. 14](#) . Secure the panel with a strut again and attach it to the anchors. Check the horizontal and vertical positions and then secure the joint with corresponding screws. The corner joint - preferably dual-drive construction screws with a disc head at the corresponding length (spacing of approx. 50 cm, distance from the edge about 10 cm) [fig. 15](#) . The longitudinal joint - screws (torx or another type) in two rows (the spacing, see above or smaller).



# NOVATOP SYSTEM INSTRUCTIONS FOR ASSEMBLY

Between the NOVATOP panels and between their joints, depending on the direction of stress (in plane and vertically to the plane of the panel) there are shear, tensile and compressive forces. The fasteners are often stressed by their combination. The connection is usually carried out with carpenter's screws, nails, pins or pegs. Due to the multilayer structure of the NOVATOP SOLID panels with different direction of fibres in individual layers, with different thickness of lamellas and the execution of individual layers, it is necessary to take care of the position and direction of installation of the connecting element in the bearing joints. During the connection, the fastener passes vertically to the fibres or parallelly with the fibres of the lamellas. With the fasteners under the axial tension, withdrawal resistance, tensile resistance and resistance to extension of the head are concerned. It is also necessary to pay attention to grooves and joints in the construction of individual panels which can influence the safety of the joint. It is important that the fastener penetrate at least into the 3rd layer of the panel vertically to the surface and it is recommended to arrange the fasteners in at least two lines. The smallest diameter of the screws should be 6mm when screwing into the surface and 8mm for the screwing

into the edge. If there is no other possibility when screwing into the edge than the position of the joints parallelly with the fibres, it is necessary to screw under an angle of 30°. The characteristic resistance against the withdrawal of the screws is calculated as follows:

$$R_{(ax,s,k)} = \frac{31 \times d^{08} \times L_{ef}^{0,9}}{1,5 \times \cos^2 \varepsilon + \sin^2 \varepsilon} \quad (v \text{ N})$$

Where d ... specific diameter of the drilling in mm,  $L_{ef}$  ... efficient depth of the drilling,  $\varepsilon$  ... for connections in surfaces  $\varepsilon = 90^\circ$ , in edges  $\varepsilon = 0$ .

The characteristic resistance against the withdrawal of special (ridge, grooved, bolting) screws is calculated as follows:

$$R_{ax,n,k} = 14 \times d^{0,6} \times L_{ef} \quad (v \text{ N})$$

where  $L_{ef}$  ... effective depth of hammering, d ... nail diameter. For CLT with joints and grooves the minimum nail should be diameter 4 mm.

Here are the following minimum distances on the surfaces and on the edges between the fasteners and the fasteners and the edges of the panel.

## FASTENERS ON THE SURFACES

fastener	a1	a2	a3,t	a3,c	a4,t	a4,c
carpenter's screws	4 x d	2,5 x d	6 x d	6 x d	6 x d	2,5 x d
nails	$(3+3-\cos\alpha) \times d$	3 x d	$(7+3 \times \cos\alpha) \times d$	6 . d	$(3+4 \times \sin\alpha) \times d$	3 x d
pegs	$(3+3-\cos\alpha) . d$	4 x d	5 x d	$4 \times d \times \sin\alpha$ (min. 4 x d)	3 x d	3 x d

$\alpha$  – the angle between the direction of the force and the direction of the fibres of the top layer

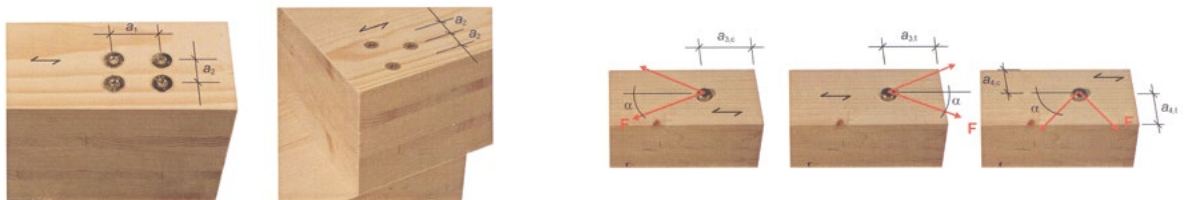

# NOVATOP SYSTEM INSTRUCTIONS FOR ASSEMBLY

## FASTENERS ON THE EDGES

fastener	a1	a2	a3,t	a3,c	a4,c
carpenter's screws	10 x d	3 x d	12 x d	7 x d	5 x d
pins and pegs	4 x d	4 x d	5 x d	3 x d	3 x d

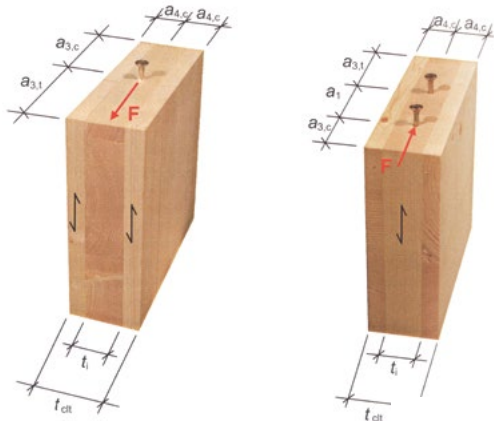

The requirement regarding the minimum thickness of the NOVATOP panel, or possibly regarding the thickness the concerned layer and the minimum depth of the fasteners are shown in the following table:

## DEPTH OF THE ATTACHMENT

fastener	minimum thickness of the concerned layer $t_i$ CLT in mm	minimum thickness (CLT) $t_{ct}$ in mm	minimum thickness of wood / depth for fastening $t_1, t_2$ in mm
screws	$d > 8$ mm: 3 x d $d \leq 8$ mm: 2 x d	10 x d	10 x d
pins	d	6 x d	5 x d

The longitudinal joint can be carried out by means of a cover plate from one side, namely with panels of thickness from 62 to 84 mm ( [Pic 16](#) or construction detail 106 a ND 107),

or by a longitudinal overlap with the thickness of panels from 84 to 124 mm ( [Pic 17](#) or construction detail ND 105).



fig. 16



fig. 17

# NOVATOP SYSTEM INSTRUCTIONS FOR ASSEMBLY

## RECOMMENDATIONS FOR ASSEMBLY OF PANELS IN VISUAL QUALITY:

When installing NOVATOP panels in visual quality, we use screws from the external side and the tightening ratchets are, if necessary, placed at the bottom of the panels (usually covered by the floor) and then at the top [fig. 18a](#) so as not to damage the visual side. In case of visual quality, the anchors can be installed also from the external side [fig. 18b](#).

With vertical joints, you can either leave a visual joint [fig. 19](#) or putty the joints (a higher labour content and a risk of small cracks). Any holes from the screws are to be puttied and sanded.

In case of panels with a double-sided visual quality, sink the connecting screws and then treat them with a plow or putty and sand.

Airtightness in visual quality is provided from the external side [fig. 20](#) (airtight tapes at the joints or airtight foils at the transition of walls and ceilings). Arrangement around windows and doors: you can leave visual joints [fig. 21](#) or you can use spruce panels or bars for trimming and covering the joints.



fig. 18b



fig. 18a



fig. 19



fig. 20



fig. 21



# NOVATOP SYSTEM INSTRUCTIONS FOR ASSEMBLY

## 3. ASSEMBLY OF CEILINGS NOVATOP ELEMENTS

Manipulation of NOVATOP ceiling elements is carried out using a crane **fig. 22**. The elements are already factory-fitted for a standard suspension system using 4 lifting straps **fig. 23** which can be provided by the supplier. Each element is fitted with an identification label stating the position number in the assembly plan **fig. 24** and the individual elements are fitted according to the assembly plan **fig. 25**. Preparation of the assembly plan is a very important phase especially for larger buildings; the plan is to be consulted with the designer in order to achieve the smoothest installation process possible.

Prior to the actual installation, it is recommended to measure the construction site and mark the raster of the element on the placement location (e.g. a wall, glued prisms, etc.). NOVATOP elements are placed in the final position using a crane, while maintaining an angle of approximately 60° between the element and the strap system **fig. 26**. It is necessary to keep the minimum placement width of 40 mm for the NOVATOP SOLID walls; when placing on other structures, an individual assessment is required. The exact position is secured by means of tightening ratches or mallets, while taking into account the position of the ribs in the element in order to avoid its damage.



fig. 23



fig. 24

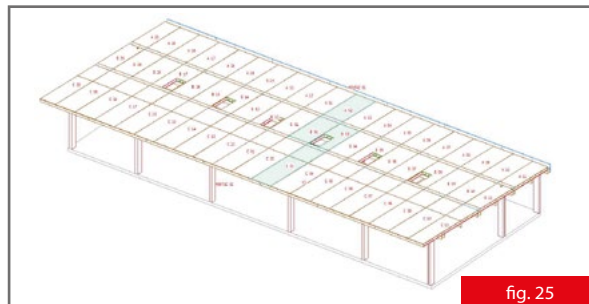

fig. 25

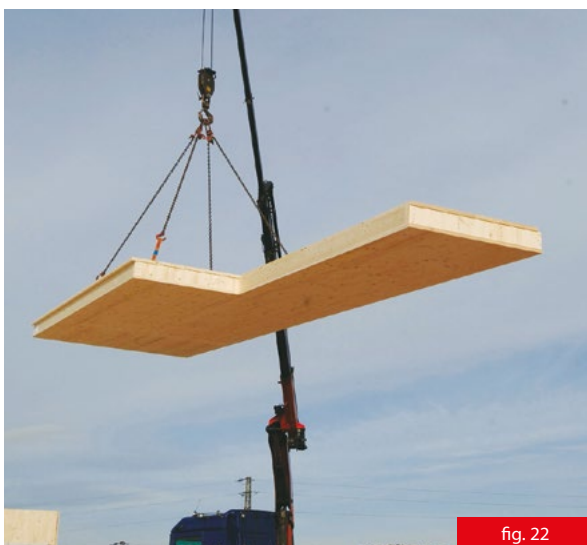

fig. 22

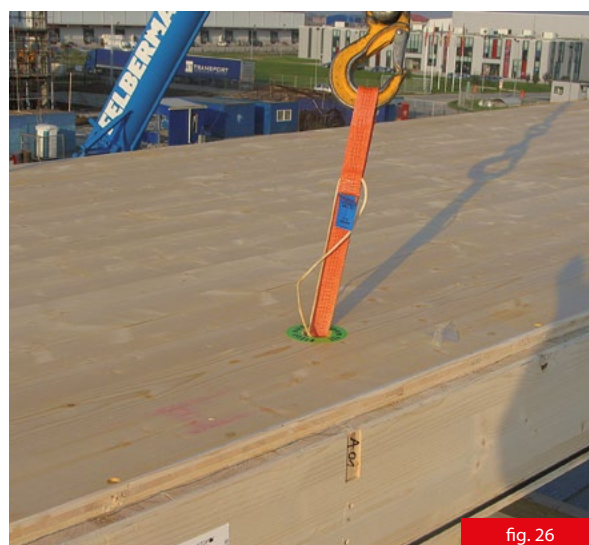

fig. 26

# NOVATOP SYSTEM INSTRUCTIONS FOR ASSEMBLY



fig. 27



fig. 28

In case of NOVATOP SOLID walls in no-visual quality, the ceiling elements are anchored to the walls from the bottom side using L profiles and construction screws of the corresponding length [fig. 27](#) or from the top side in case of visual quality [fig. 28](#).

The longitudinal joint of the ceiling elements will be secured again using screws through the overhang [fig. 29](#).

To ensure airtightness of the joint, airtight foil can be used (extending from the inner side around the ceiling element and then to the inner part of the connecting wall panel). Another option is to make the connection from the outer side again with the help of airtight foil sealed with tapes, or to use a milled fastener between the two floors, which is glued with a PU adhesive [fig. 30](#). The next floor is to be placed on a sealing tape (according to the purpose of the use) due to the interruption of the acoustic bridges [fig. 31, 32](#).

**WARNING:**

When using wet processes during the construction (e.g. anhydrite floors), it is important to secure sufficient ventilation of the building in order to prevent excessive moisture build-up in the structure, but it is also important to gradually dry out the structure so as to avoid a rapid reduction in moisture (e.g. when using electric driers).

The recommended relative humidity of the environment in which NOVATOP panels are installed is 55% at 20°C. Wood cracks may occur due to low air humidity.

**Warning:** Wood properties of this product are maintained, so they respond to changes in temperature and humidity by shrinking or, possibly, by swelling. Improper storage and use in extreme conditions (extreme temperatures and humidity) can cause cracking and distortions. The producer assumes no liability for the damage of the product due to improper storage, processing, unsuitable use or nonobservance of work procedures during the assembly.

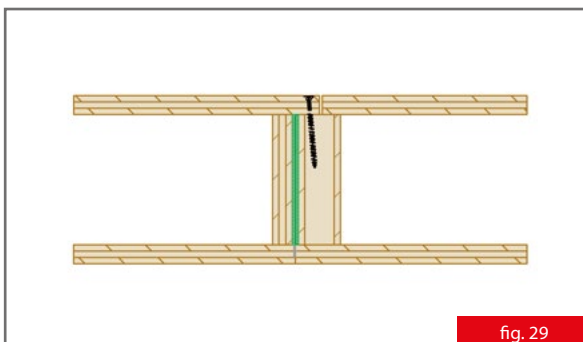

fig. 29



fig. 30



fig. 31



fig. 32

# NOVATOP SYSTEM INSTRUCTIONS FOR ASSEMBLY

## EXAMPLES OF PLACEMENTS OF NOVATOP ELEMENTS



Placement on foundation strips



Placement on concrete ring and glued prism



Placement on steel girder



Placement on wooden prisms



Placement on NOVATOP walls



Placement on frame structure

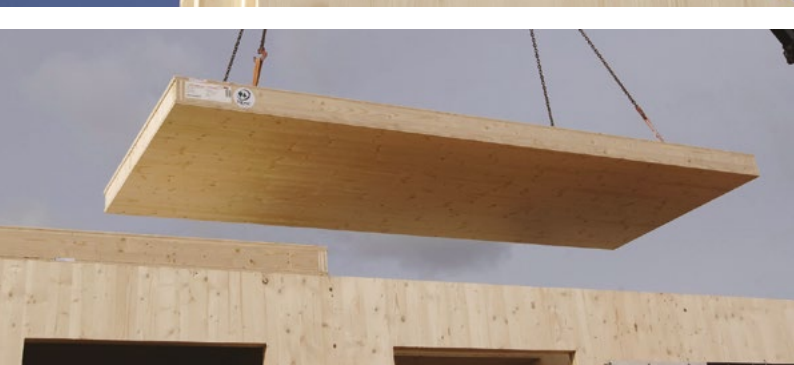
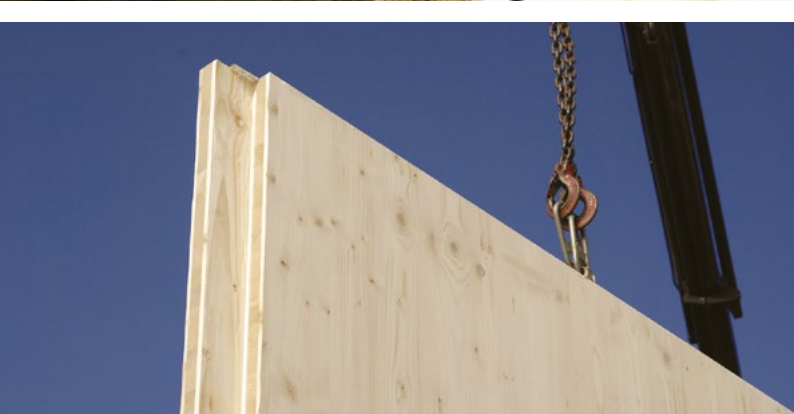

**Manufacturer: AGROP NOVA a.s.**  
Ptenský Dvůrek 99  
798 43 Ptení  
Czech Republic  
Tel.: +420 582 397 856  
novatop@agrop.cz  
novatop-system.com

Manufacturer certificates:



The technical documentation and the certificates can be downloaded at [www.novatop-system.cz](http://www.novatop-system.cz)